

## DIN W48×H48mm 8 Pin plug counter

### ■ Features

- Upgraded counting speed : 1cps / 30cps / 2kcps / 5kcps
- Decimal point setting(Fixed decimal point of display)
- Wide range of power supply : 100-240VAC 50/60Hz  
12-24VAC/DC(Option)
- Memory protection for 10years(Using non-volatile semiconductor)
- Selectable Up/Down for counting value
- Built-in Microprocessor



**⚠ Please read "Caution for your safety" in operation manual before using.**

### ■ Ordering information

<b>FS</b>	<b>4</b>	<b>A</b>	
			Output
			Digit
			Item
		A	Single preset
		B	Indicator
		4	9999(4digit)
		5	99999(5digit)
		FS	8-pin plug counter

### ■ Specifications

Model	Single preset	<b>FS4A</b>	—
	Totalizer(Indicator)	—	<b>FS5B</b>
Digit		4digit	5digit
Digit size		W3.8×H7.6mm	W4×H8mm
Power supply	AC Voltage type	100-240VAC 50/60Hz	
	AC/DC Voltage type	100-240VAC 50/60Hz, 12-24VAC/DC universal(option)	
Allowable voltage range		90 to 110% of rated voltage	
Power consumption	AC Voltage type	• Indicator : Approx. 4.7VA • Single preset : Approx. 5.7VA(240VAC 50/60Hz)	
	AC/DC Voltage type	• Indicator : Approx. 4.5VA • Single preset : Approx. 5.5VA(240VAC 50/60Hz) • Indicator : Approx. 2.8W • Single preset : Approx. 3W(24VDC)	
Max. counting speed for CP1, CP2		Selectable 1cps/30cps/2kcps/5kcps by internal DIP switch	
Min. input signal width	RESET input	Approx. 20ms	
Input	COUNT IN	No-voltage input • Impedance at short-circuit : Max. 470kΩ • Residual voltage at short-circuit : Max. 1VDC • Impedance at open-circuit : Min. 100kΩ	
	RESET		
One-shot output time		0.05 to 5sec.	
Control output	Con-tact	Type	SPST(1a)
		Capacity	250VAC 3A resistive load
Memory protection		Approx. 10 years(When using non-volatile semiconductor memory)	
External power		12VDC ±10% 50mA max.	
Insulation resistance		100MΩ(at 500VDC megger)	
Dielectric strength		2000VAC 50/60Hz for 1 minute	
Noise strength	AC power	±2kV the square wave noise(pulse width : 1μs) by the noise simulator	
	DC power	±500V the square wave noise(pulse width : 1μs) by the noise simulator	
Vibration	Mechanical	0.75mm amplitude at frequency of 10 to 55Hz(for 1 min.) in each of X, Y, Z directions for 1 hour	
	Malfunction	0.5mm amplitude at frequency of 10 to 55Hz(for 1 min.) in each of X, Y, Z directions for 10 minutes	
Shock	Mechanical	300m/s <sup>2</sup> (approx. 30G) in each of X, Y, Z directions for 3 times	
	Malfunction	100m/s <sup>2</sup> (approx. 10G) in each of X, Y, Z directions for 3 times	
Relay life cycle	Mechanical	Min. 10,000,000 operations	—
	Electrical	Min. 100,000 operations(250VAC 3A at resistive load)	—
Environment	Ambient temperature	-10 to 55°C, storage: -25 to 65°C	
	Ambient humidity	35 to 85%RH, storage: 35 to 85%RH	
Unit weight		Approx. 130g	Approx. 120g

※Environment resistance is rated at no freezing or condensation.

(A)	Photo electric sensor
(B)	Fiber optic sensor
(C)	Door/Area sensor
(D)	Proximity sensor
(E)	Pressure sensor
(F)	Rotary encoder
(G)	Connector/Socket
(H)	Temp. controller
(I)	SSR/ Power controller
(J)	Counter
(K)	Timer
(L)	Panel meter
(M)	Tacho/ Speed/ Pulse meter
(N)	Display unit
(O)	Sensor controller
(P)	Switching mode power supply
(Q)	Stepper motor& Driver&Controller
(R)	Graphic/ Logic panel
(S)	Field network device
(T)	Software
(U)	Other

# FS Series

## Connections

### FS4A

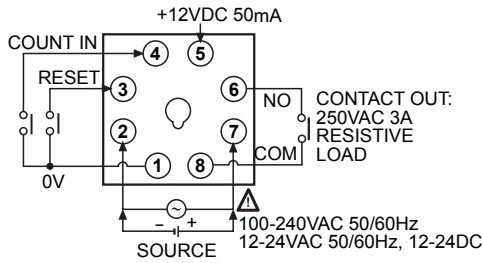

### FS5B

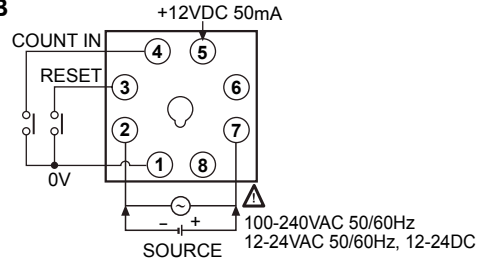

## Dimensions

### Bracket

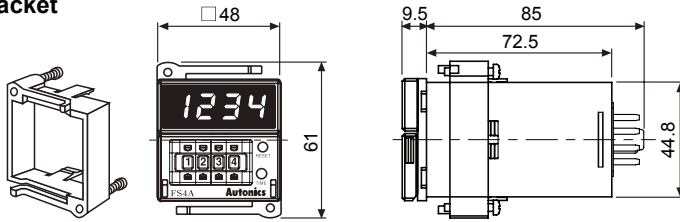

### Panel cut-out

(unit: mm)

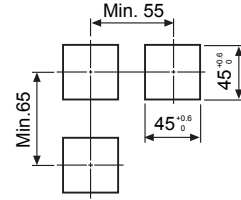

### Socket(Sold separately)

#### PG-08

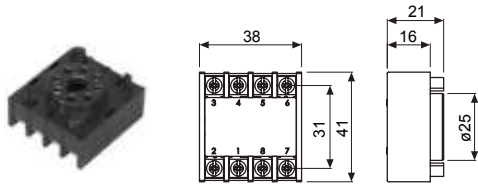

#### PS-08

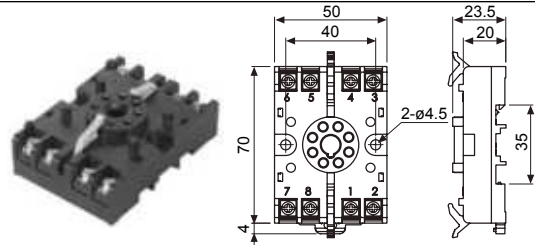

## Input connections

### No-voltage input(NPN)

#### Solid-state input(Standard sensor : NPN output type sensor)

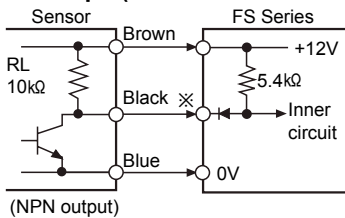

※CP1, CP2(INHIBIT), RESET input

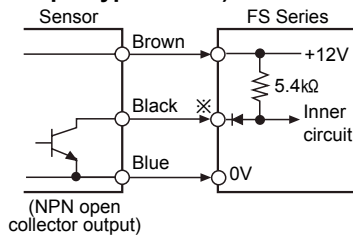

(NPN open collector output)

#### Contact input

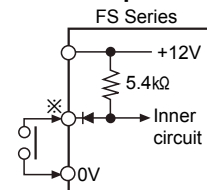

※Please select the counting speed as 30cps when it is used for counter.

### Voltage input(PNP)

FXY series is for no voltage input type, it is not available to count applying DC voltage from the external. For using PNP type sensor, please use as the following to count.

#### PNP output sensor

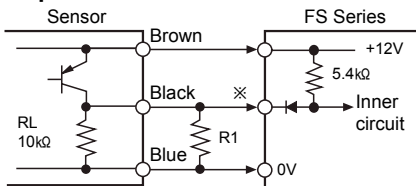

※Please set R1 value to make the composed resistance of RL+R1 as Max. 470Ω is an impedance for short-circuit.  
※CP1, CP2(INHIBIT), RESET input

#### PNP open collector output type sensor

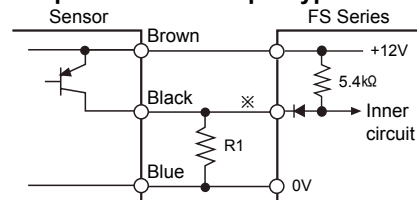

※In case of PNP open collector output type sensor, please connect lower than 470Ω of R1 to input terminal before using.

# 8 Pin Plug type Counter

## Input & output connections

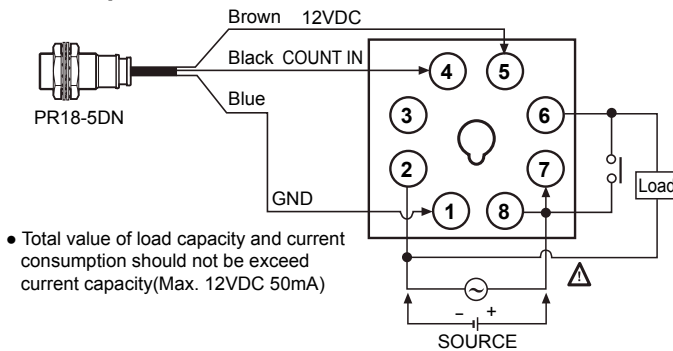

- Total value of load capacity and current consumption should not be exceed current capacity(Max. 12VDC 50mA)

- Please select proper capacity of load not to exceed contact capacity. Contact capacity : 250VAC 3A Max. Contact type : 1a

## Description of inner DIP switches

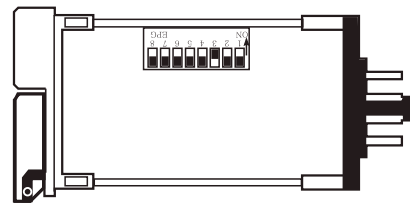
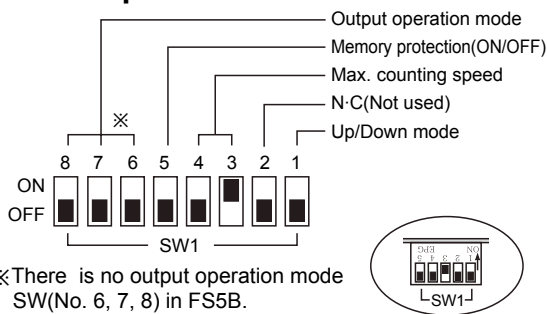

- ※ The max. counting speed is upgraded as 8 DIP SW numbers.

### Max. counting speed

SW1	Function						
<table border="1"> <tr> <td>ON</td> <td>3</td> <td>4</td> </tr> <tr> <td>OFF</td> <td>3</td> <td>4</td> </tr> </table>	ON	3	4	OFF	3	4	1cps
ON	3	4					
OFF	3	4					
<table border="1"> <tr> <td>ON</td> <td>3</td> <td>4</td> </tr> <tr> <td>OFF</td> <td>3</td> <td>4</td> </tr> </table>	ON	3	4	OFF	3	4	30cps
ON	3	4					
OFF	3	4					
<table border="1"> <tr> <td>ON</td> <td>3</td> <td>4</td> </tr> <tr> <td>OFF</td> <td>3</td> <td>4</td> </tr> </table>	ON	3	4	OFF	3	4	2kcps
ON	3	4					
OFF	3	4					
<table border="1"> <tr> <td>ON</td> <td>3</td> <td>4</td> </tr> <tr> <td>OFF</td> <td>3</td> <td>4</td> </tr> </table>	ON	3	4	OFF	3	4	5kcps
ON	3	4					
OFF	3	4					

### Up/Down mode

SW1	Function				
<table border="1"> <tr> <td>ON</td> <td>1</td> </tr> <tr> <td>OFF</td> <td>1</td> </tr> </table>	ON	1	OFF	1	Down mode
ON	1				
OFF	1				
<table border="1"> <tr> <td>ON</td> <td>1</td> </tr> <tr> <td>OFF</td> <td>1</td> </tr> </table>	ON	1	OFF	1	Up mode
ON	1				
OFF	1				

### Memory protection

SW1	Function				
<table border="1"> <tr> <td>ON</td> <td>5</td> </tr> <tr> <td>OFF</td> <td>5</td> </tr> </table>	ON	5	OFF	5	Disable the memory protection
ON	5				
OFF	5				
<table border="1"> <tr> <td>ON</td> <td>5</td> </tr> <tr> <td>OFF</td> <td>5</td> </tr> </table>	ON	5	OFF	5	Enable the memory protection
ON	5				
OFF	5				

## Setting function of decimal point

Display the decimal point.



RUN mode

- ※ Press RESET button for over 3sec., it advances to decimal point setting mode.

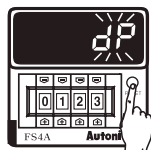

- ※ When "dP" is flashing, one touch the Reset button.

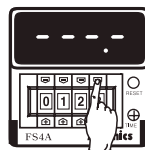

- ※ Set the position of decimal point using  $\uparrow$ ,  $\downarrow$  button of digital switch.

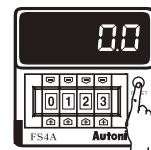

Return to RUN mode

- ※ Press RESET button for over 3sec., it returns to RUN mode.

### Changing the decimal point

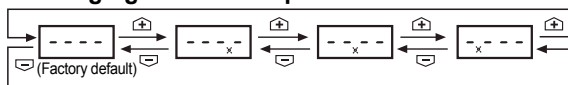

- ※ It returns to RUN mode if no RESET button or digital switch is applied for 60sec. in decimal point setting status.

- ※ The decimal point setting is existed in indication type.

(A) Photo electric sensor

(B) Fiber optic sensor

(C) Door/Area sensor

(D) Proximity sensor

(E) Pressure sensor

(F) Rotary encoder

(G) Connector/Socket

(H) Temp. controller

(I) SSR/ Power controller

(J) Counter

(K) Timer

(L) Panel meter

(M) Tacho/ Speed/ Pulse meter

(N) Display unit

(O) Sensor controller

(P) Switching mode power supply

(Q) Stepper motor& Driver&Controller

(R) Graphic/ Logic panel

(S) Field network device

(T) Software

(U) Other

# FS Series

## Counting operation of indication mode(Indication model)

### Up mode

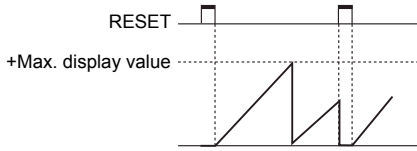

### Down mode

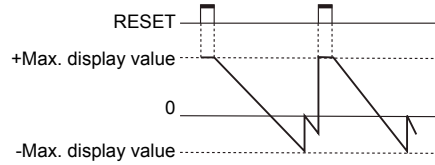

## Output operation mode

	← One-shot output(0.05 to 5sec.)	← Retained output	
Output mode (SW1)	ON <input type="checkbox"/> 4 OFF <input checked="" type="checkbox"/> <b>Up mode</b>	ON <input type="checkbox"/> 4 OFF <input checked="" type="checkbox"/> <b>Down mode</b>	Operation after count up
<b>F</b>	RESET Preset 0 Output	RESET Preset 0 Output	The display value continues until reset signal is applied then output is held. • Retained output will be maintained until Reset signal is applied.
<b>F</b>	RESET Preset 0 Output	RESET Preset 0 Output	Display value and retained output are maintained until Reset signal is applied.
<b>C</b>	RESET Preset 0 Output	RESET Preset 0 Output	The display value returns to reset start status when display value is reached to setting value.
<b>R</b>	RESET Preset 0 Output	RESET Preset 0 Output	The display value is held until output is OFF then returns to reset start status.
<b>K</b>	RESET Preset 0 Output	RESET Preset 0 Output	The display value continues until reset signal is applied.
<b>P</b>	RESET Preset 0 Output	RESET Preset 0 Output	The display value is held during one-shot output time, counting process is returned to reset start status as soon as output is ON.
<b>Q</b>	RESET Preset 0 Output	RESET Preset 0 Output	The display value continues during one-shot output time.
<b>S</b>	RESET Preset 0 Output	RESET Preset 0 Output	• Up input mode -Output is ON when (Display value) $\geq$ (Setting value) • Down input mode -Output is ON when (Display value) $\leq$ (Zero)

※One-shot output time is set by front TIME adjuster.

# 8 Pin Plug type Counter

## ■ Proper usage

### ◎ Reset function

#### ● Reset

In case of changing the input mode after supplying the power, please take a external reset or manual reset. **If reset is not executed, the counter will be working as previous mode.**

#### ● Reset signal width

It is reset perfectly when the reset signal is applied during **min. 20ms** regardless of the contact input & solid-state input.

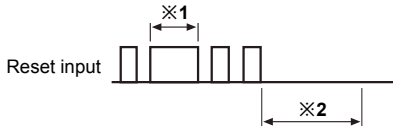

※1: In case of a contact reset, it is reset perfectly if the ON time of reset signal is applied during min. 20ms even though chattering is occurred.

※2: It can be input the signal of CP1&CP2 after min. 50ms from closing time of reset signal.

### ◎ Sensor power

The power 12VDC which is provided to sensor is built in it. Please use it under Max. 50mADC.

### ◎ Min. signal width

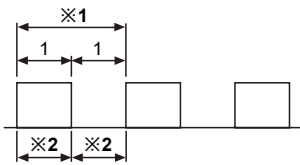

※1: Please make duty ratio(ON/OFF) 1:1.

※2: Min. signal width

- 1cps : Min. 0.5sec.
- 30cps : Min.16.7ms
- 2kcps : Min. 0.25ms
- 5kcps : Min.0.1ms

### ◎ Max. counting speed

This is a response speed per 1 sec. when the duty ratio (ON:OFF) of input signal is 1:1. If the duty ratio is not 1:1, the width between ON and OFF should be over min. signal width and the response speed is getting slower against input signal. If either ON or OFF signal is shorter than minimum signal width, this product may not respond.

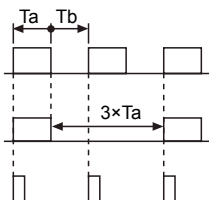

Therefore Ta(ON width) and Tb(OFF width) needed to be over min. signal width.

Max. counting speed is 1/2 value of rated spec. when duty ratio is 1:3.

It can not respond if it is smaller than min. signal width(Ta).

### ◎ Error display

Error signal	Error description	Returning method
Err 0	Zero setting status	Change the setting value to non zero status

※When Error is displayed, the output continues OFF state.

※There is no Error function in indicator.

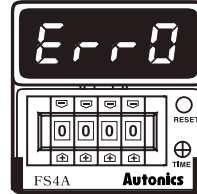

### ◎ Detach the case from body

While pushing the Lock part with with driver to the front, push the terminal block.

1) Widen the lock device toward outside, push the plug to the front.

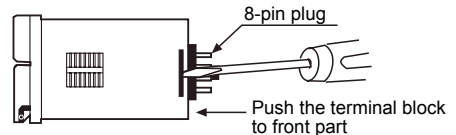

2) Detach the case.

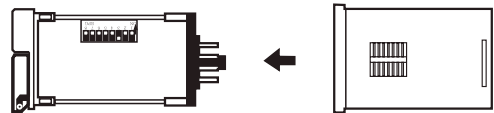

※Please be careful to use with tools, it may cause injury.

### ◎ Power

The inner circuit voltage starts to rise up for the first 100ms after power on, the input may not work at this time.

And also the inner circuit voltage drops down for the last 500ms after power off, the input may not work at this time.

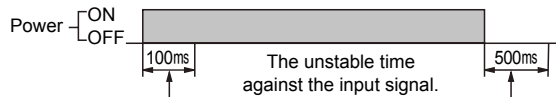

(A) Photo electric sensor

(B) Fiber optic sensor

(C) Door/Area sensor

(D) Proximity sensor

(E) Pressure sensor

(F) Rotary encoder

(G) Connector/ Socket

(H) Temp. controller

(I) SSR/ Power controller

(J) Counter

(K) Timer

(L) Panel meter

(M) Tacho/ Speed/ Pulse meter

(N) Display unit

(O) Sensor controller

(P) Switching mode power supply

(Q) Stepper motor& Driver&Controller

(R) Graphic/ Logic panel

(S) Field network device

(T) Software

(U) Other